

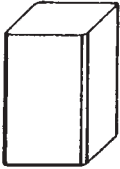

MODELOS ESTÁNDAR / BASIC SHAPES / MODÈLES STANDARD

<p>1</p> 	<p>2</p> 	<p>3</p> 	<p>4</p> 
<p>5</p> 	<p>6</p> 	<p>7</p> 	<p>8</p> 
<p>9</p> 	<p>10</p> 	<p>11</p> 	<p>12</p> 
<p>13</p> 	<p>14</p> 	<p>15</p> 	<p>16</p> 
<p>17</p> 	<p>18</p> 	<p>19</p> 	<p>20</p> 
<p>21</p> 	<p>22</p> 	<p>23</p> 	<p>24</p> 

<p>25</p> 	<p>26</p> 	<p>27</p> 	<p>28</p> 
<p>29</p> 	<p>30</p> 	<p>31</p> 	<p>32</p> 
<p>33</p> 	<p>34</p> 	<p>35</p> 	<p>36</p> 
<p>37</p> 	<p>38</p> 	<p>39</p> 	<p>40</p> 
<p>41</p> 	<p>42</p> 	<p>43</p> 	<p>44</p> 
<p>45</p> 	<p>46</p> 	<p>47</p> 	<p>48</p> 

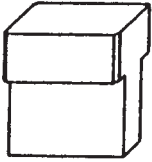
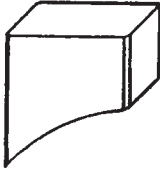
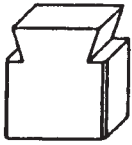
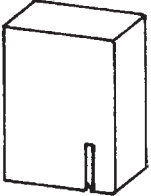
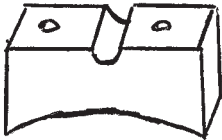
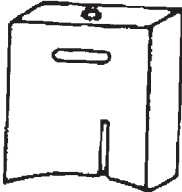
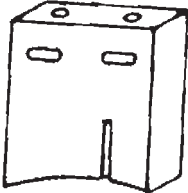
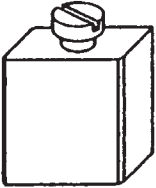
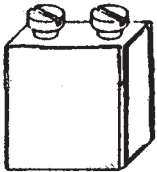
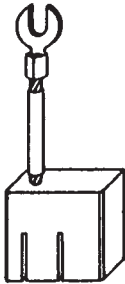
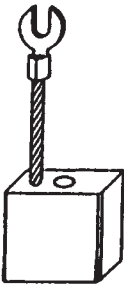
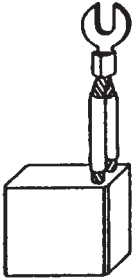
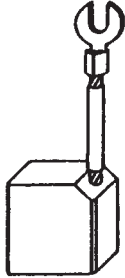
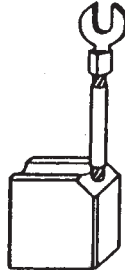
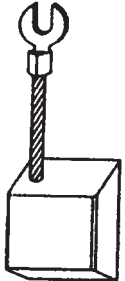
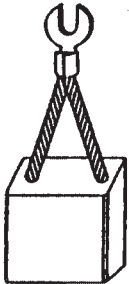
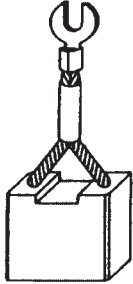
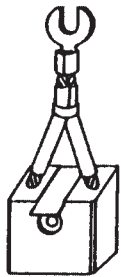
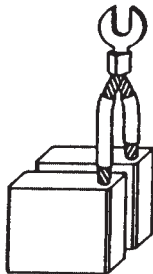
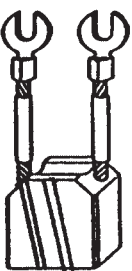
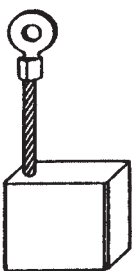
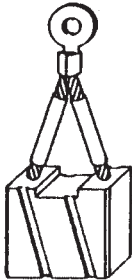
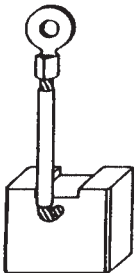
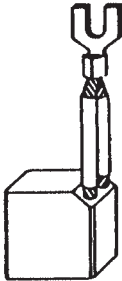
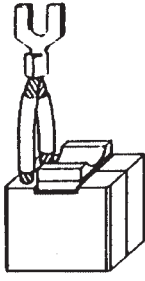
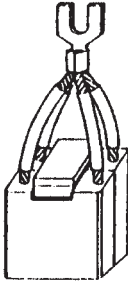
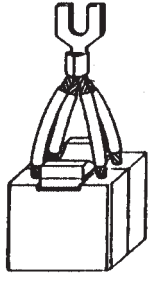

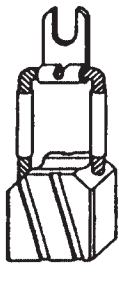
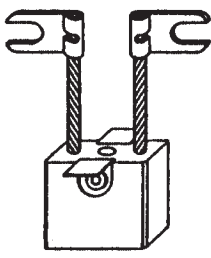
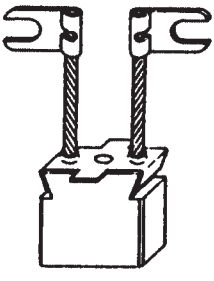
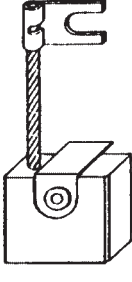
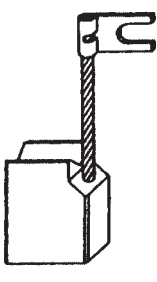
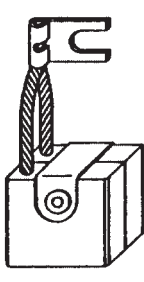
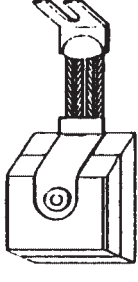
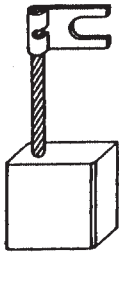
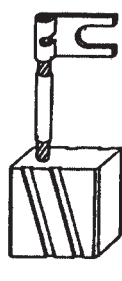
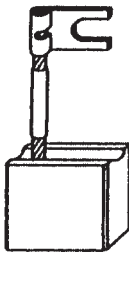
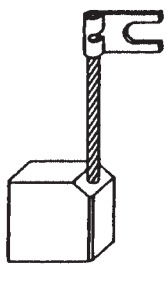
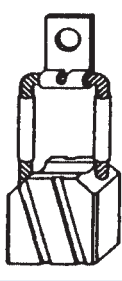
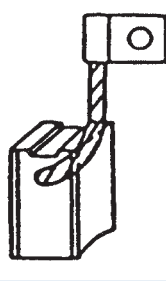
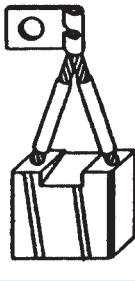
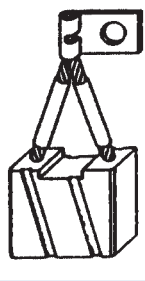
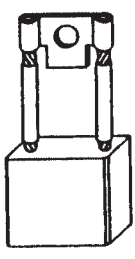
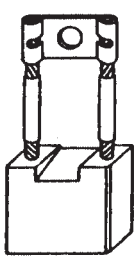
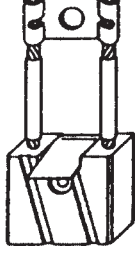
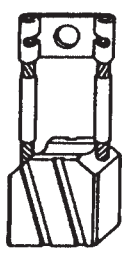
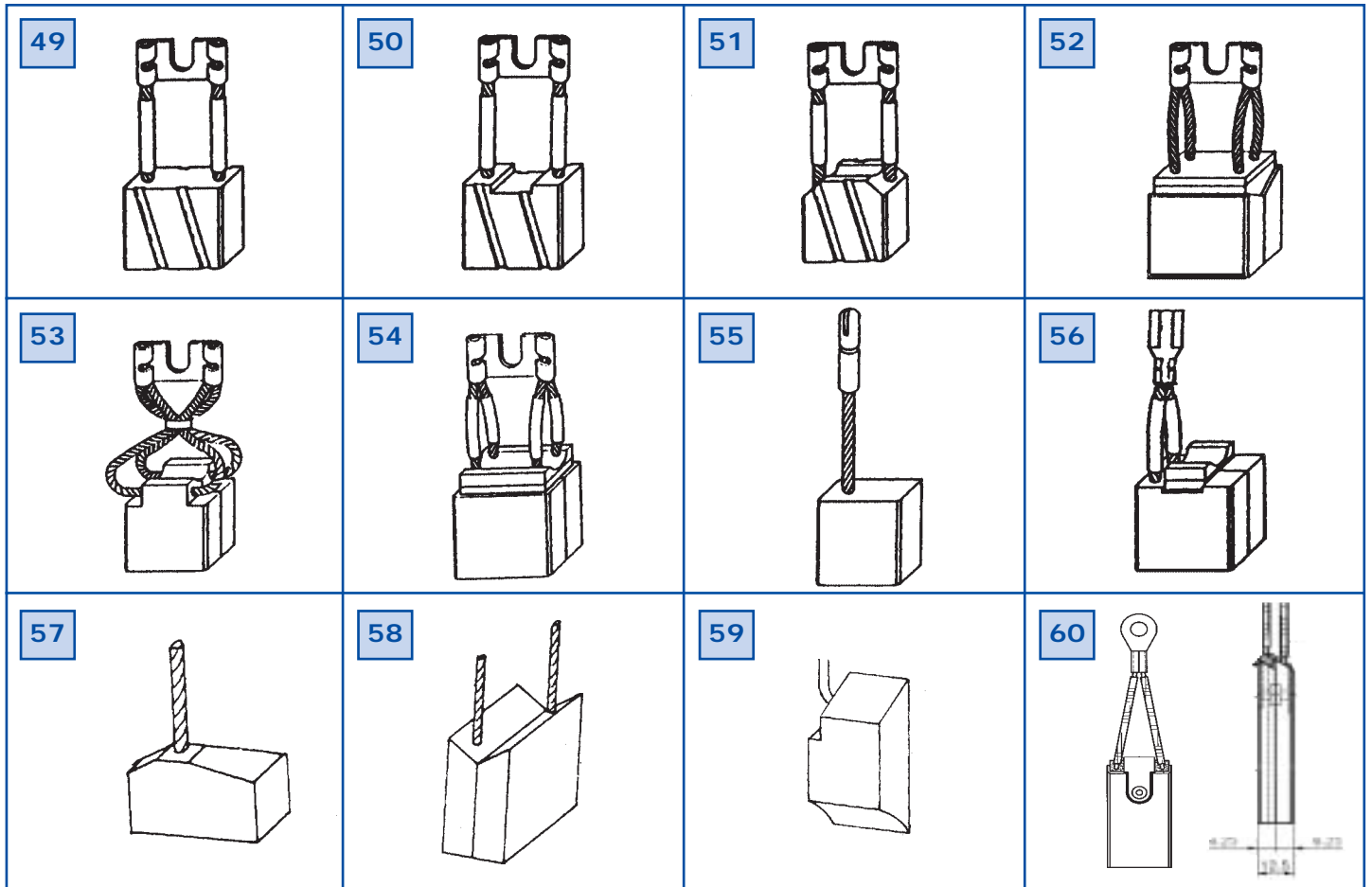
**CARBON ELECTRICO PARA CONTACTOS  
FROTADORES DE PUENTE GRÚA  
RULINAS PARA TRANSFORMADORES, ETC.**



**PALETAS Y ROTORES PARA COMPRESORES Y BOMBAS DE VACIO**

El carbón y el grafito, debido a sus propiedades particulares, son los materiales más utilizados para la fabricación de paletas y rotores, paracompresores y bombas de vacío

**TROWELS AND ROTORS FOR COMPRESSORS AND VACUUM PUMPS**

The coal and the graphite, due to their particular properties, are the materials more used for the manufacture of trowels and rotors, for compressors and pumps of emptiness

**PALETTES ET ROTORS POUR COMPRESSEURS ET BOMBES deVIDE**

Le charbon et le graphite, étant donné ses propriétés particulières, sont les matériaux les plus utilisés pour la fabrication palettes et rotors, pour des compresseurs et des bombes de vide

